

Improving RGA durability and endurance.

Dave Seymour
RGA10
October 2011

Abstract

Hidden Analytical has manufactured Quadrupole Mass Spectrometers since 1982. Thousands of RGA's have been supplied to customers worldwide.

After a period of use a proportion of these instruments return to be serviced or repaired.

The detailed records of these units have been studied. The challenges to improve longevity and reliability are discussed.



Manufacturing

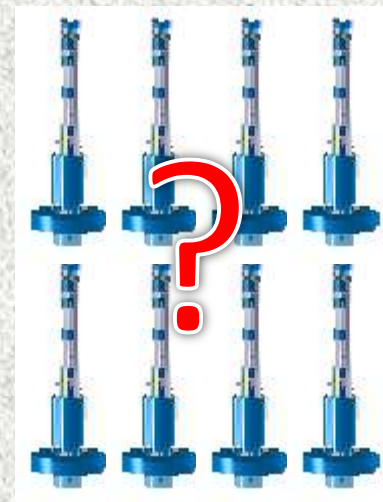

Customer sites



Service





Analysis of RGA service records

Broadly categorised as follows;

Contamination

Interface/RF/Cable electrical or electronic failure

Physical damage (excludes feedthru)

Detector end of life* or failure

Broken feedthru/vacuum failure

Wiring disconnect (gauge)

Other

No fault



Broken feedthru



Wiring disconnect



Detector end of life



Contamination

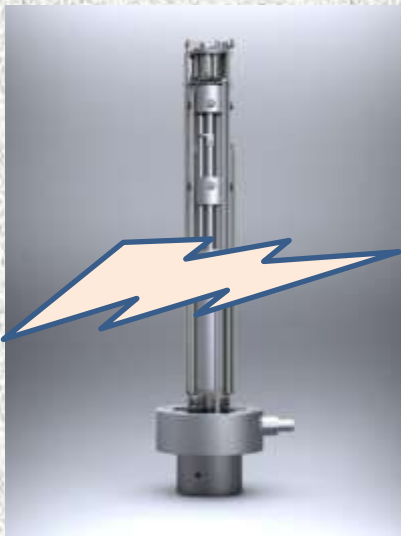

Physical damage

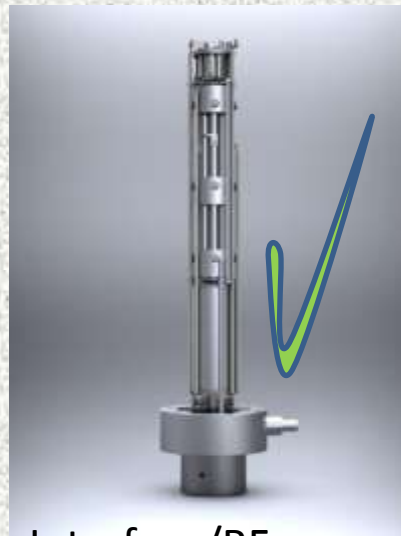

Interface/RF
electronic failure

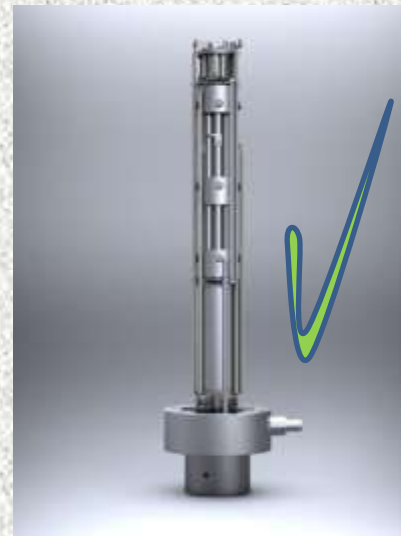

No fault



Other



Manufacturing

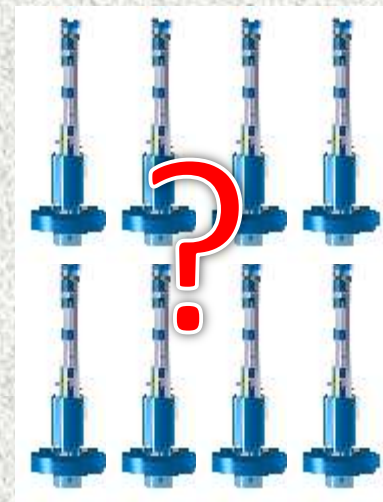

Customer sites

Service



Average age of returning instruments is 6 years 7 months.

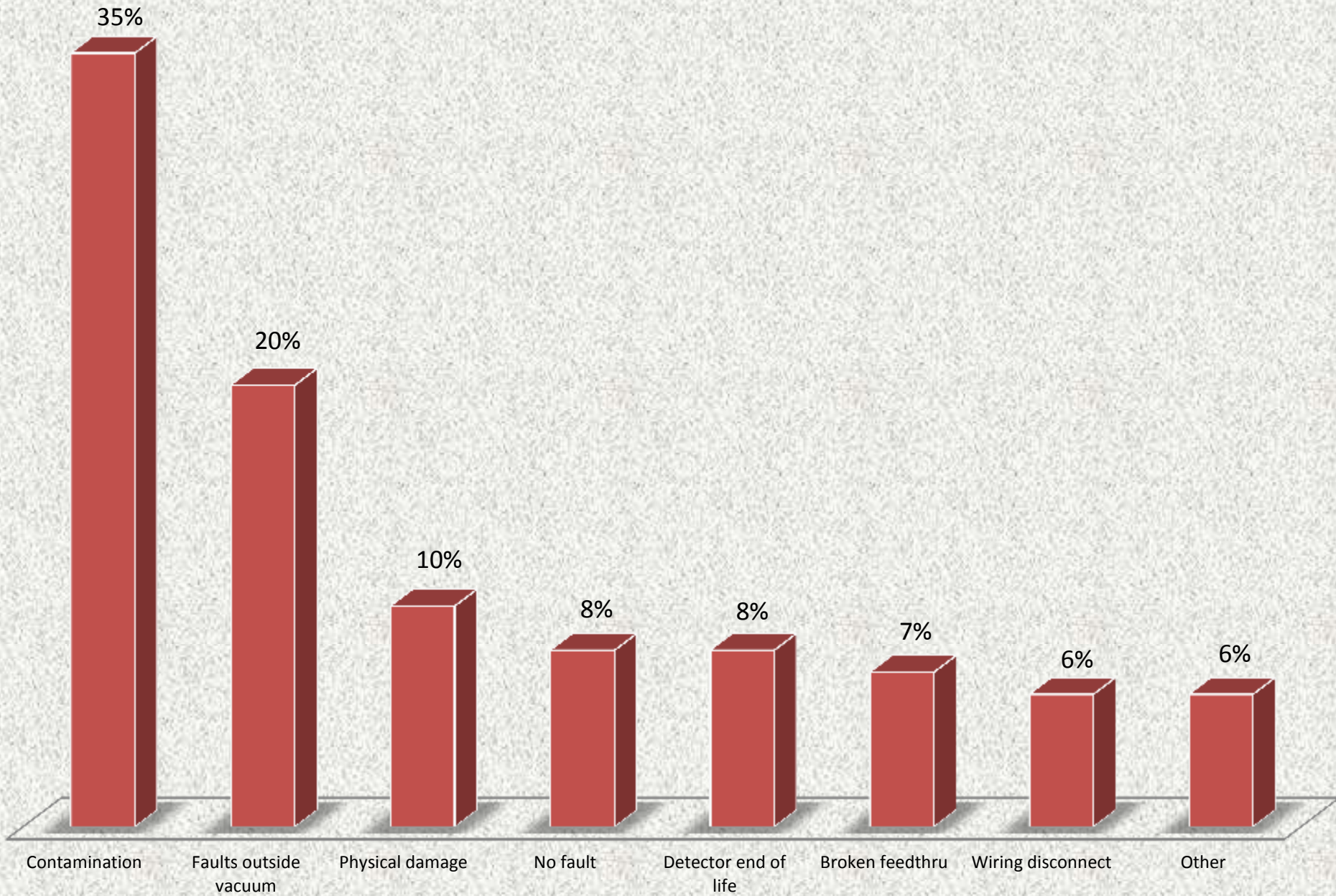

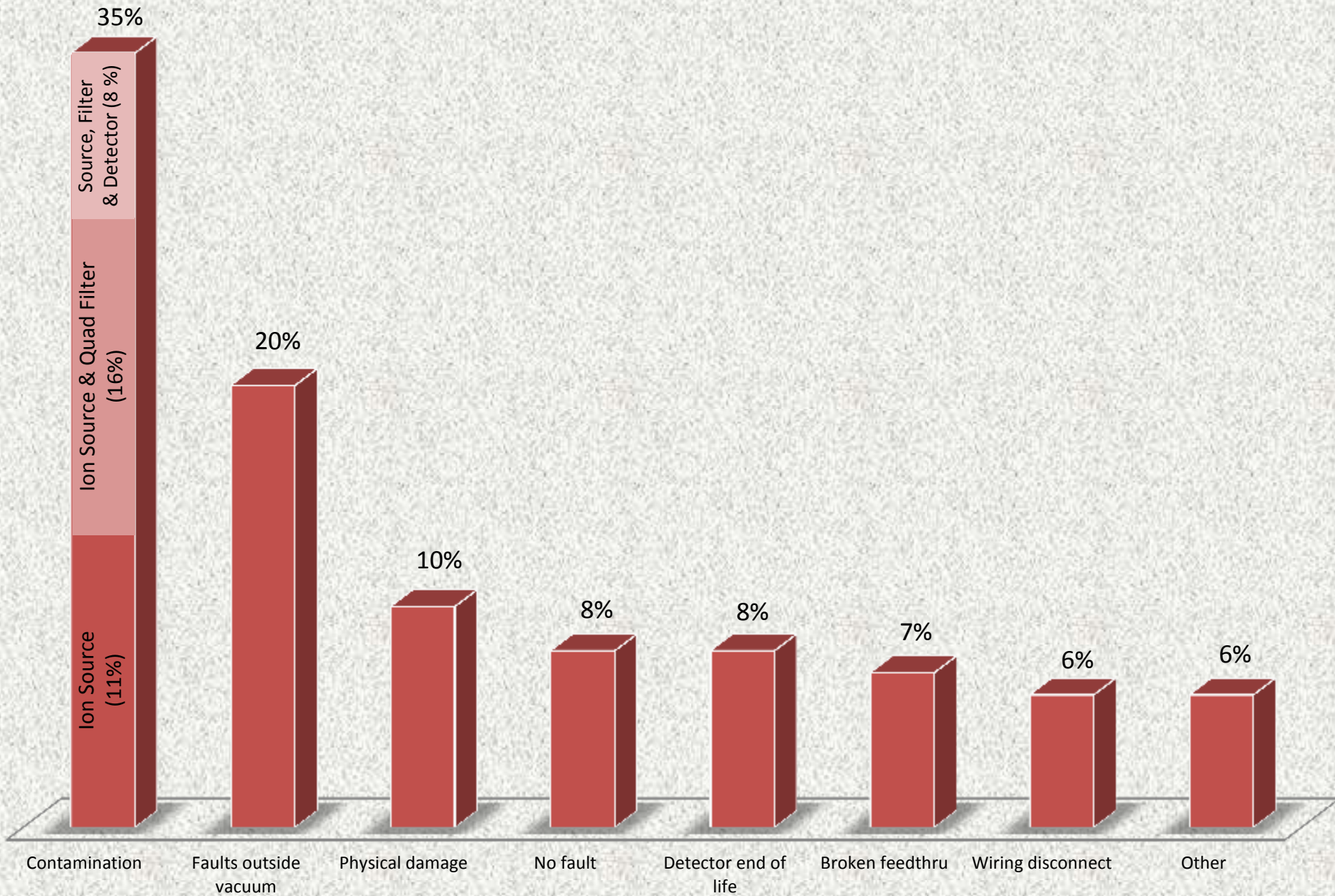



11%

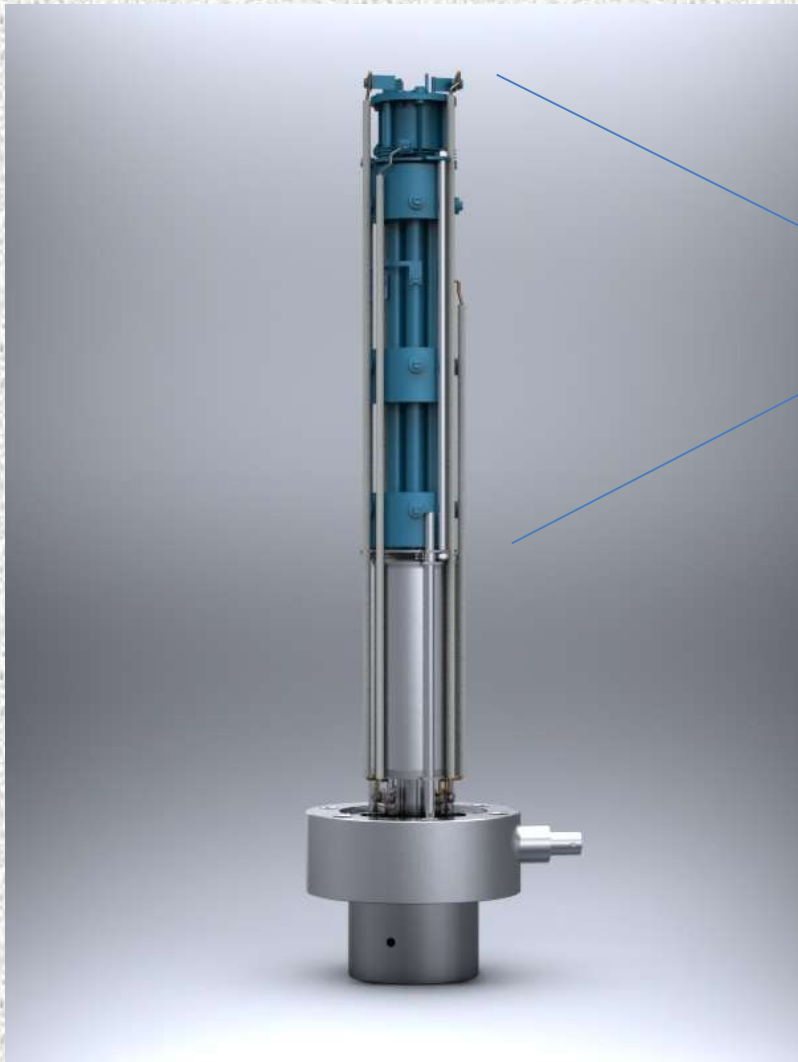

11%

16%

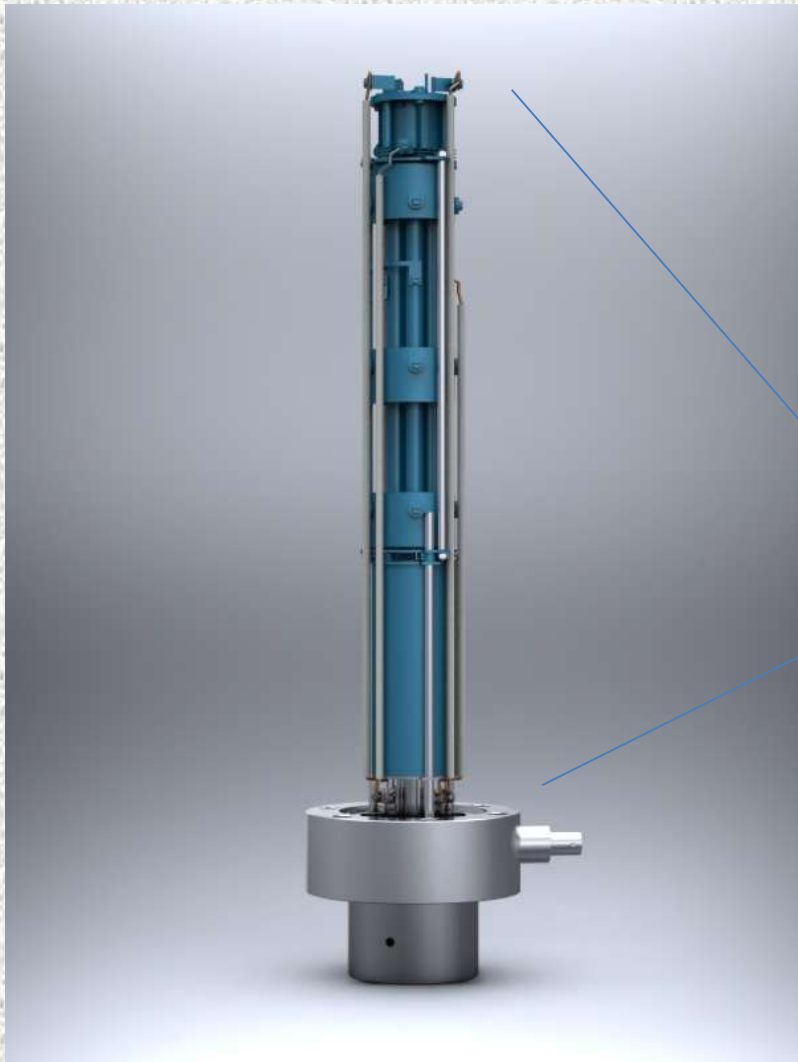

11%

16%

8%

Total 35%

Detector lifetime ;

Detector contamination $\approx 8\%$

Detector life issues $\approx 8\%$

16% multiplier replacements.

Average age of units having this work is;

6 years 6 months





Partial Pressure (Torr)

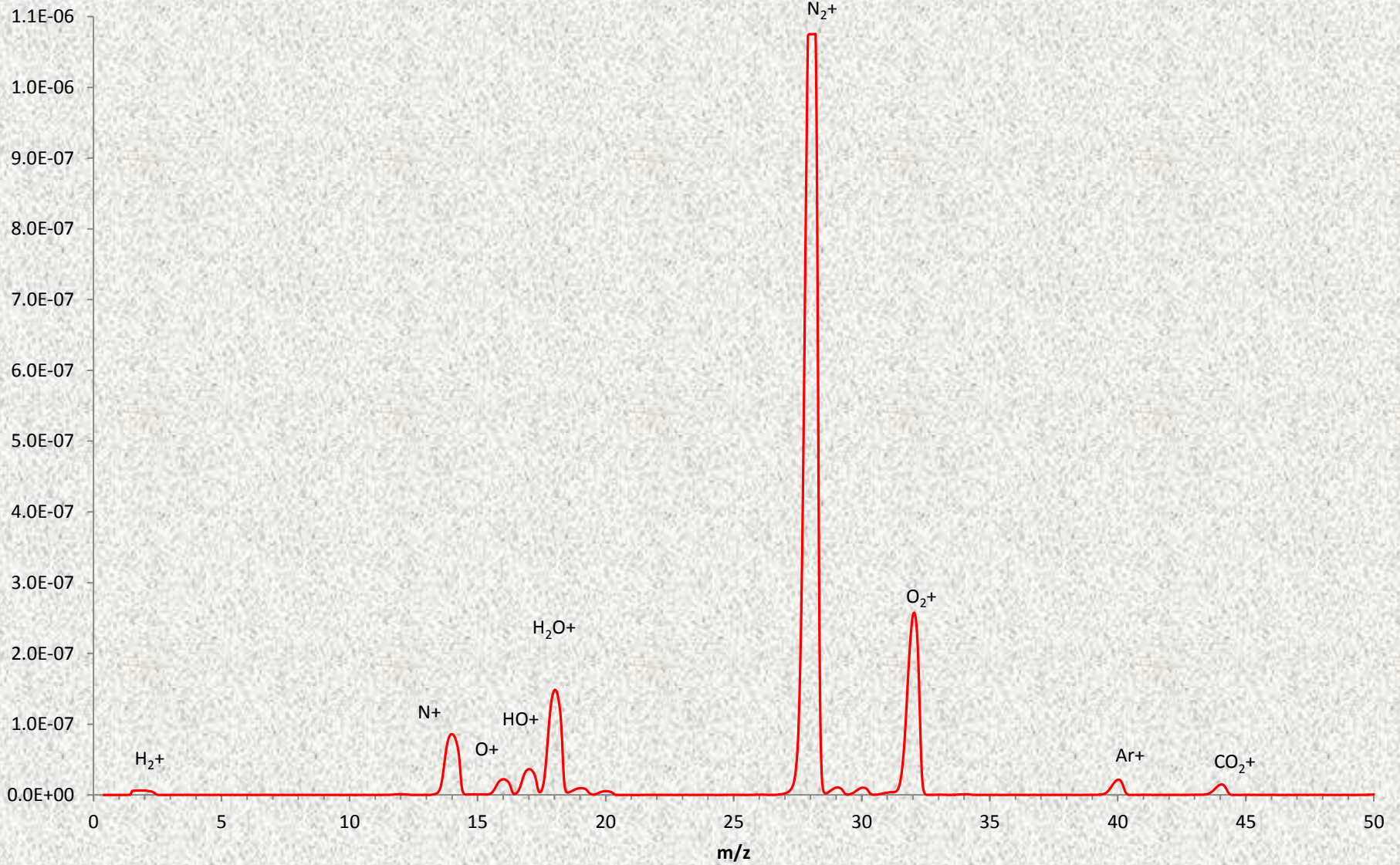

Partial Pressure (Torr)

X100

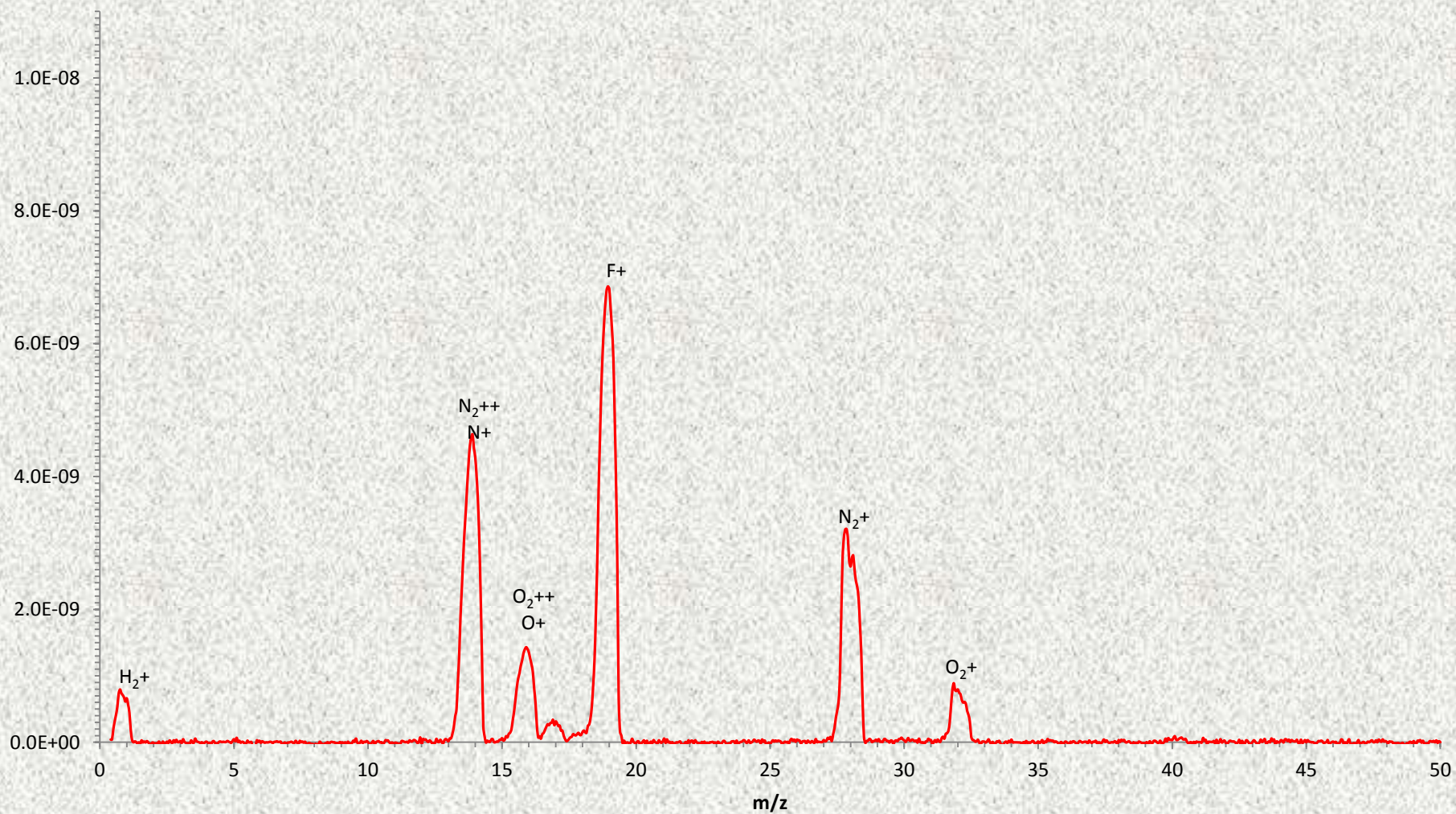

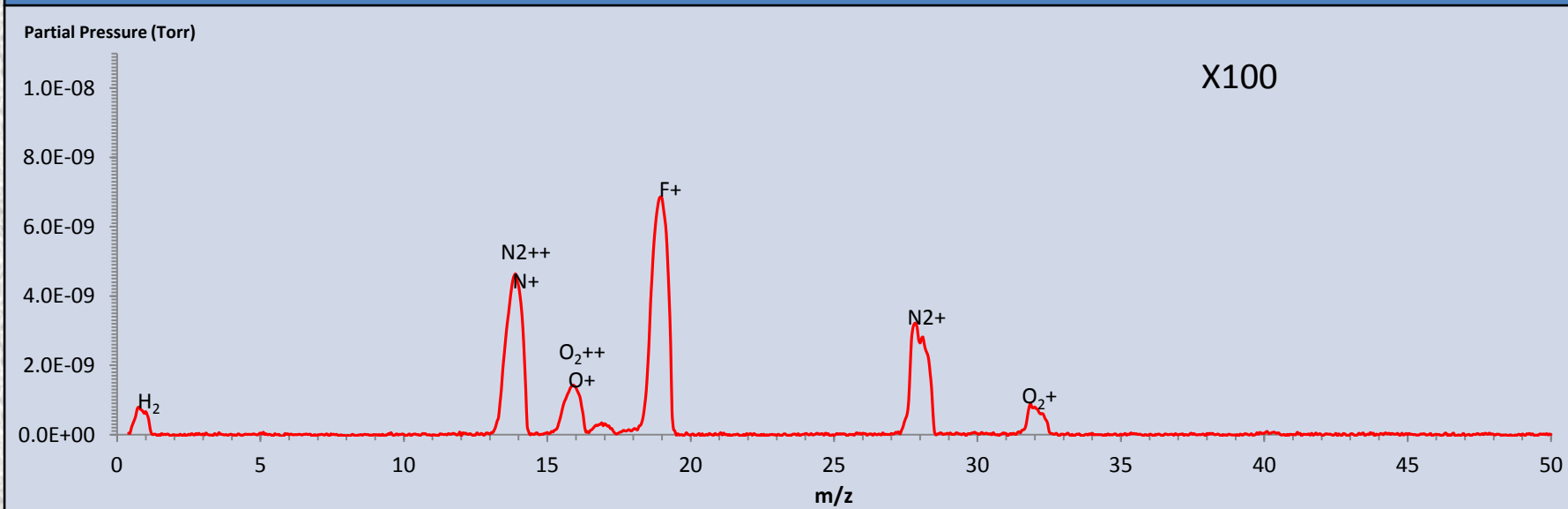
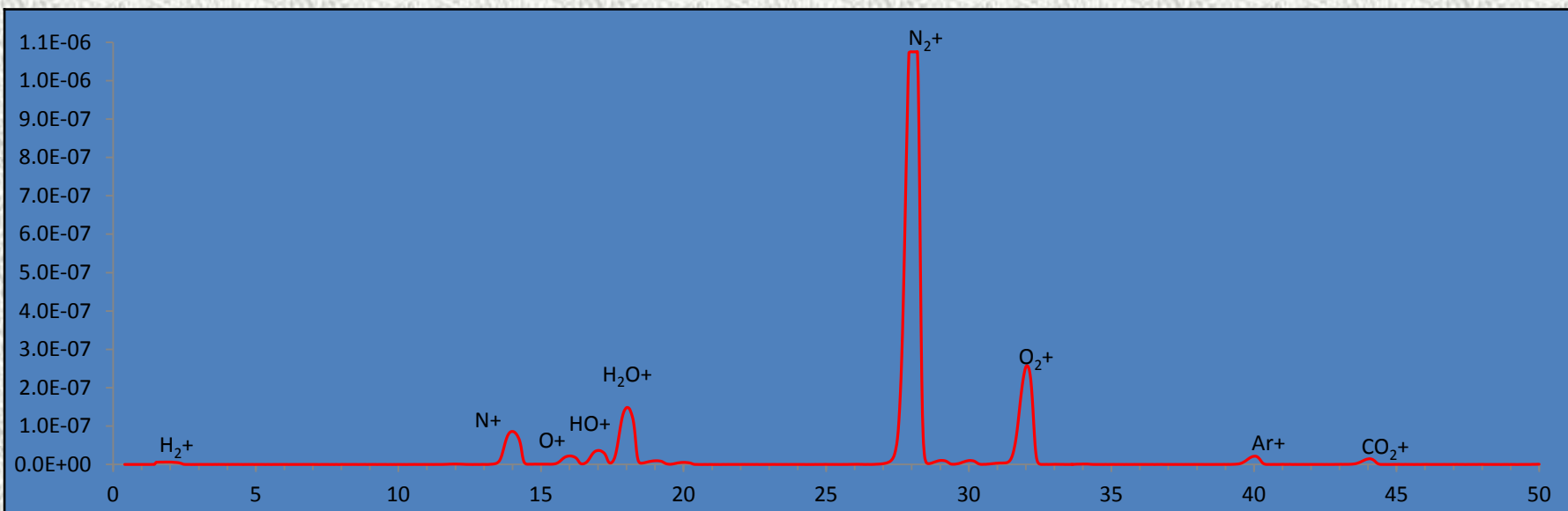

Secondary Ion Mass Spectrometry



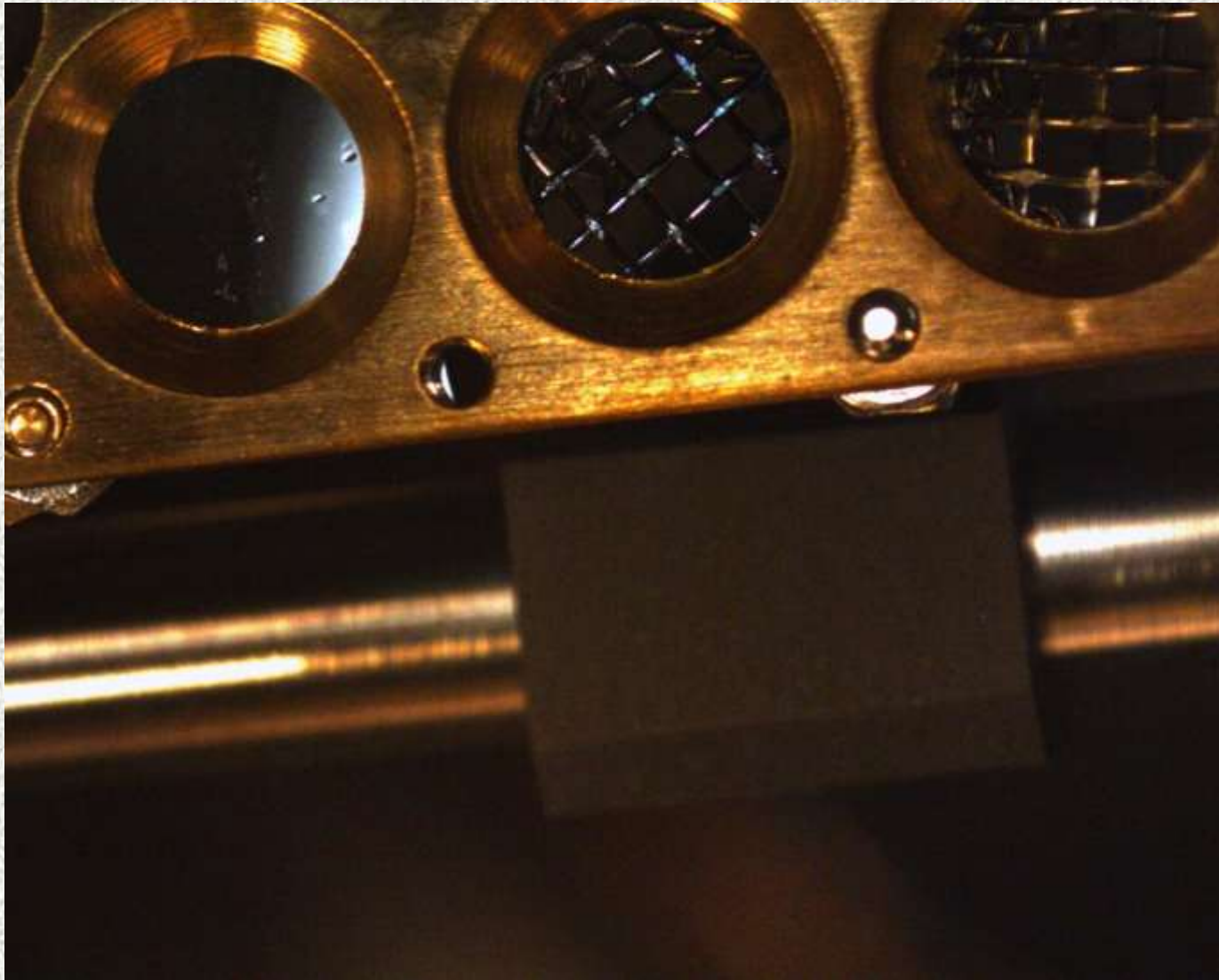

SIMS with 5Kv Cs primary ions

Clean Cage Positive Ion SIMS

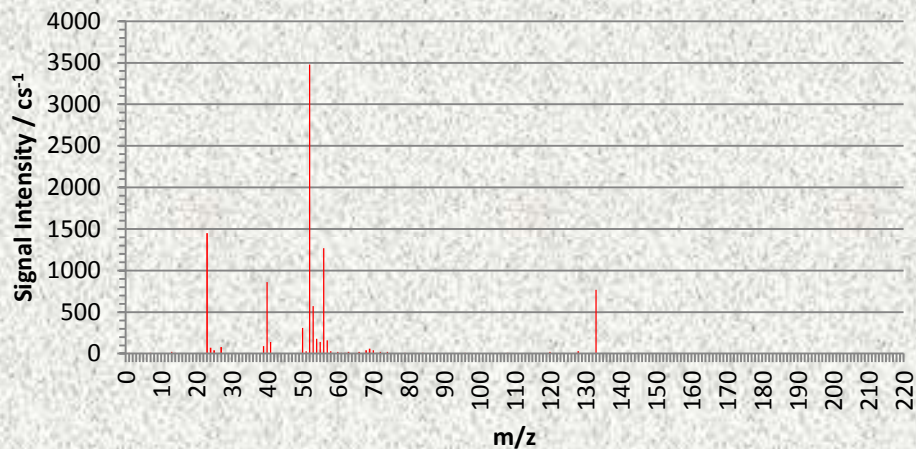

Clean Cage Negative Ion SIMS

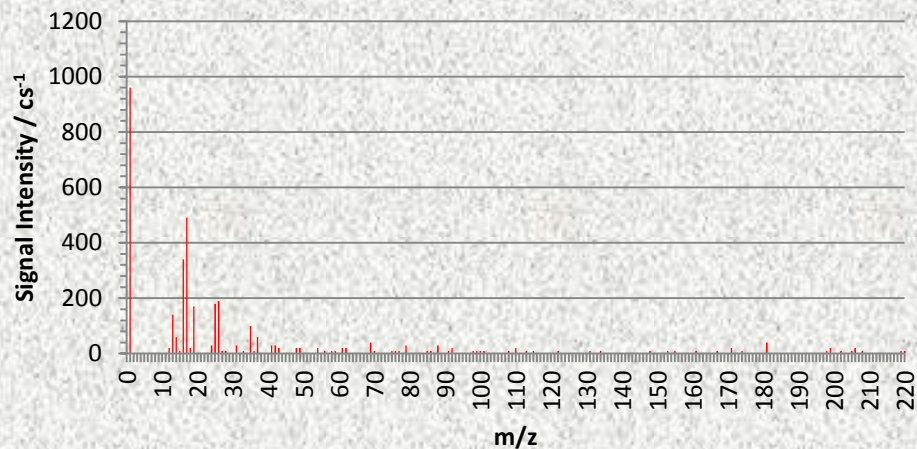

Contaminated cage Positive Ion SIMS

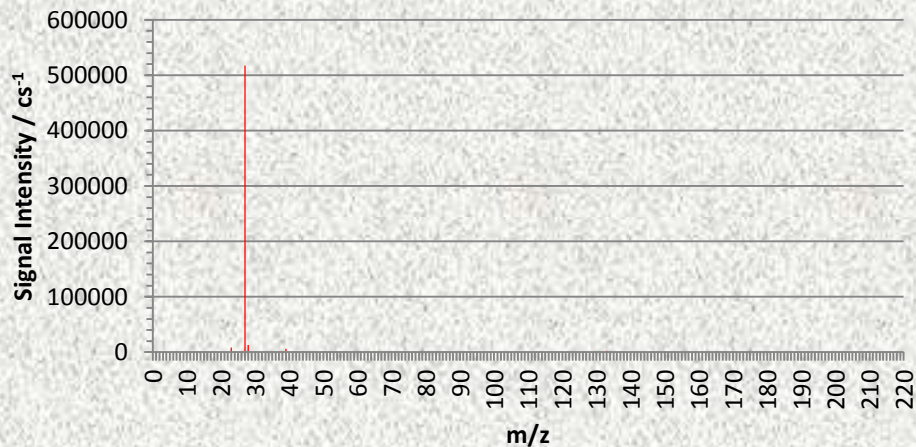

Contaminated cage Negative Ion SIMS

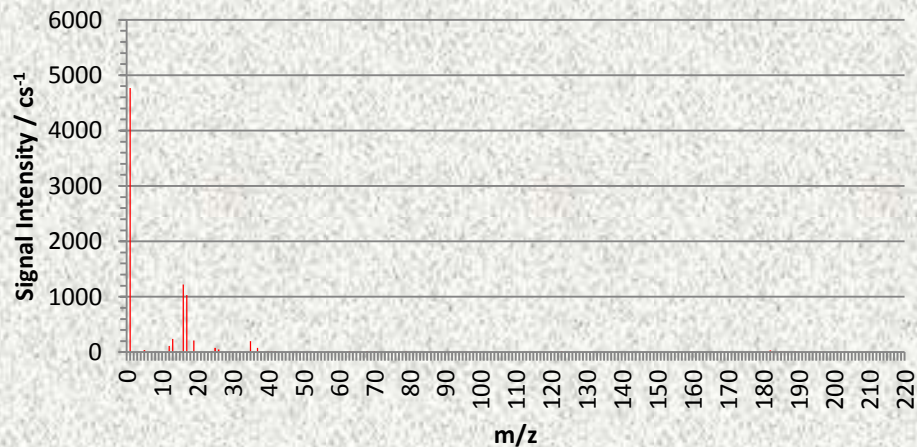

Secondary ion mass spectrum

Positive

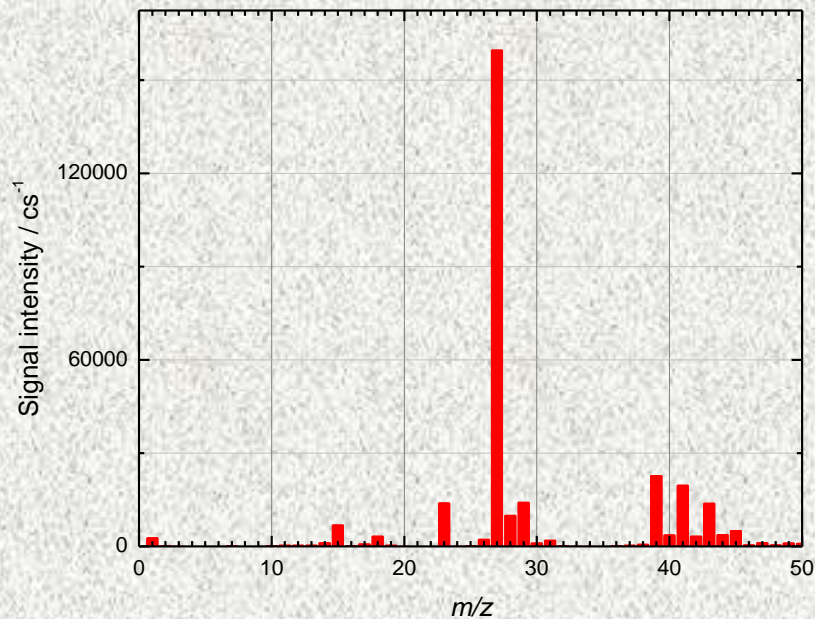

Very clean Aluminium signal
 $m/z=27$

Negative

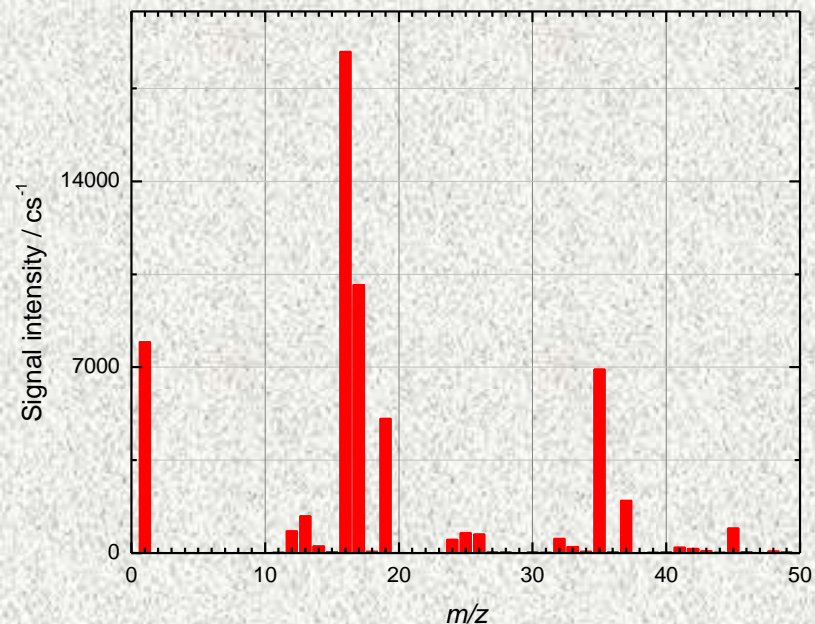

Oxygen peak at $m/z = 16$ and
OH at $m/z = 17$. There is also
evidence of F at $m/z=19$ and Cl
at $m/z 35$ and 37

SIMS depth profile

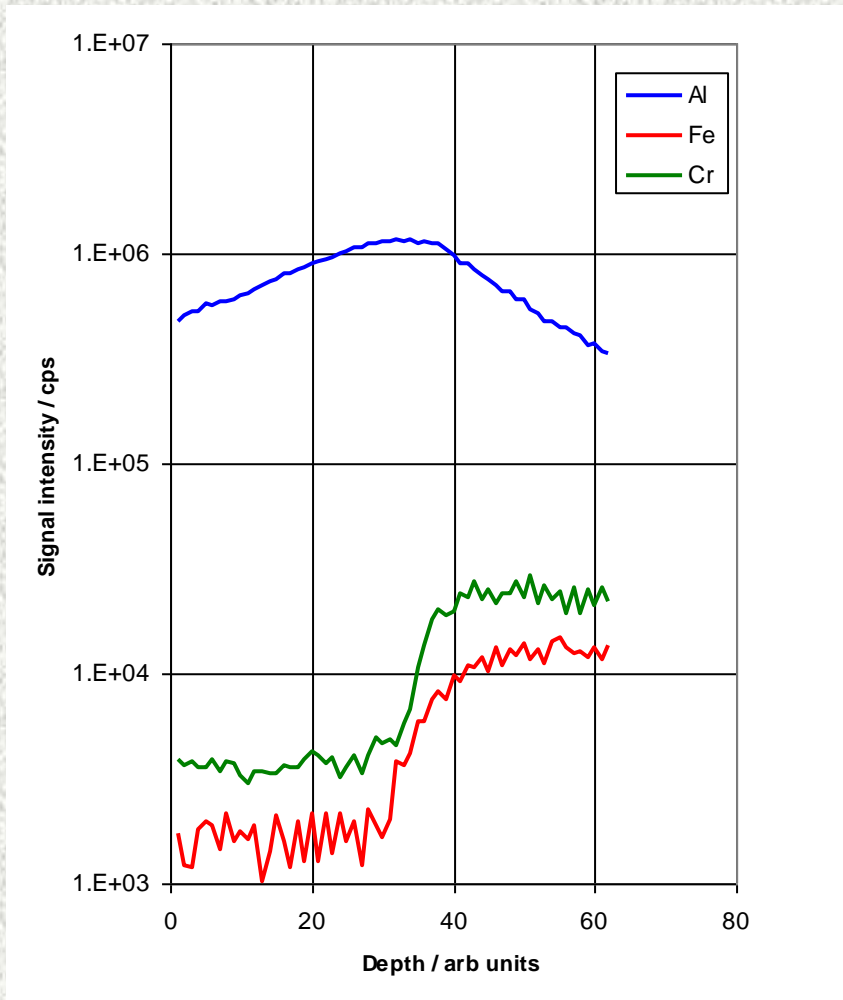

From a system using TMA (Trimethylaluminum) and O₃ for the ALD of alumina

Clean Cage Positive Ion SIMS

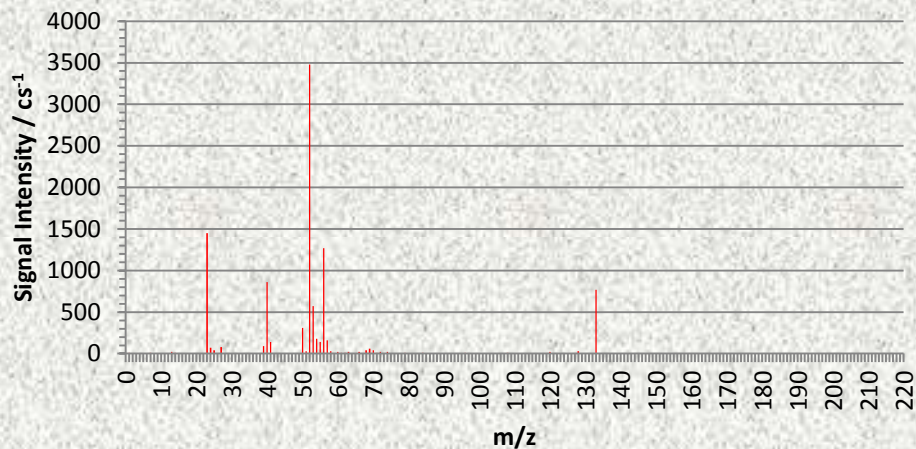

Clean Cage Negative Ion SIMS

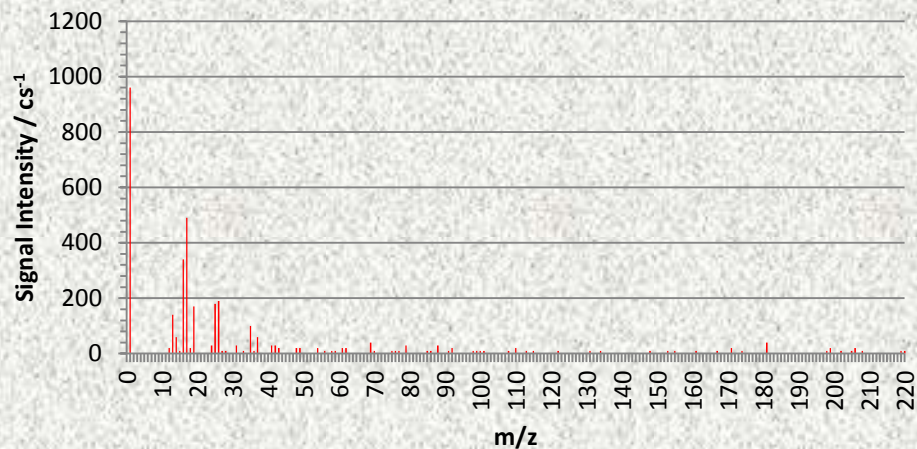

Positive Ion SIMS

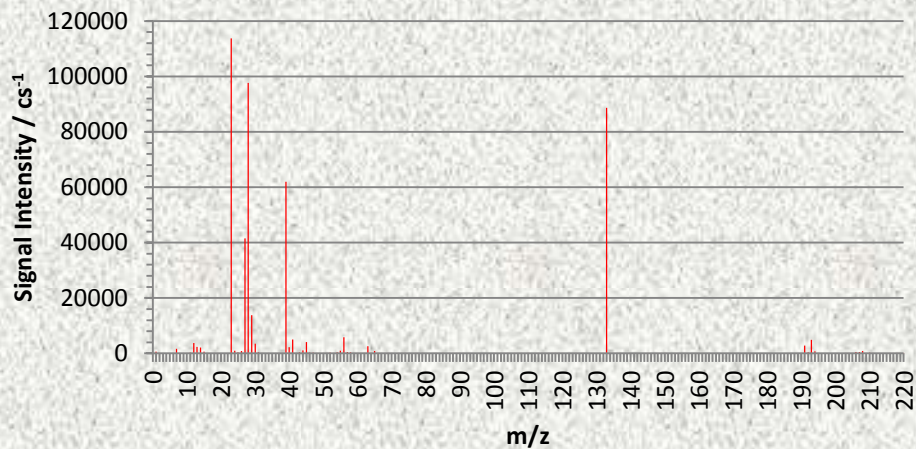

Negative Ion SIMS

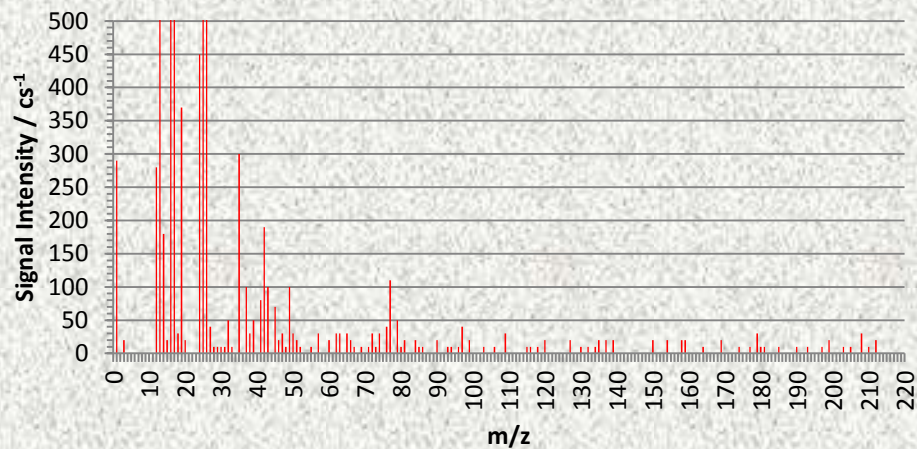

Contaminated with silicon/silica

Clean Cage Positive Ion SIMS

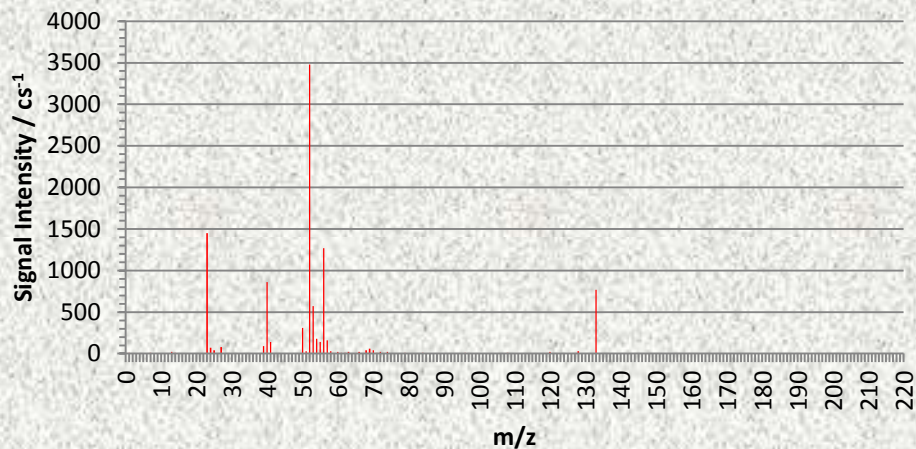

Clean Cage Negative Ion SIMS

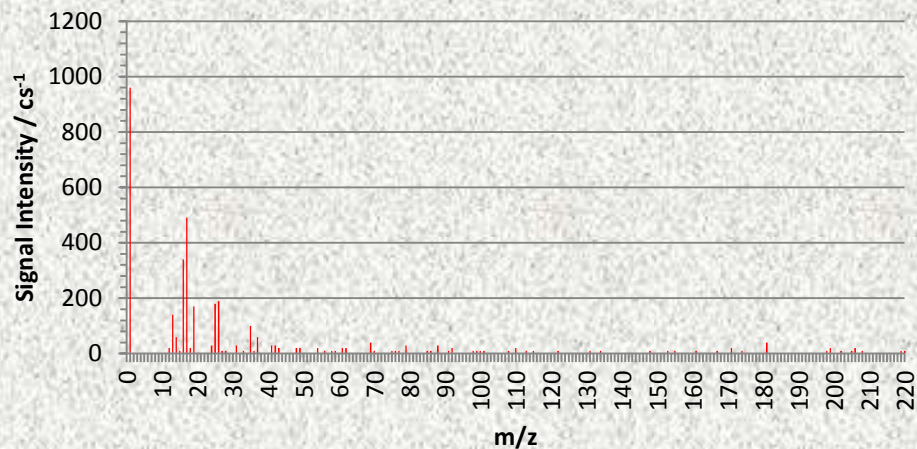

Positive Ion SIMS

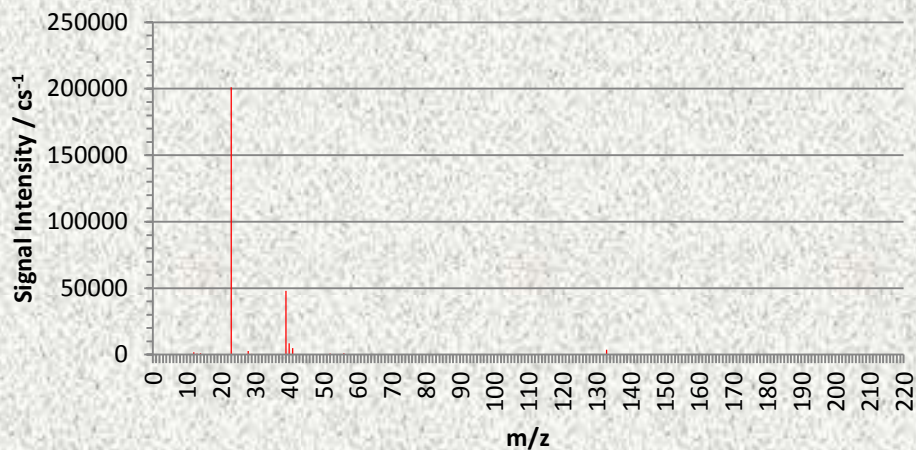

Negative Ion SIMS

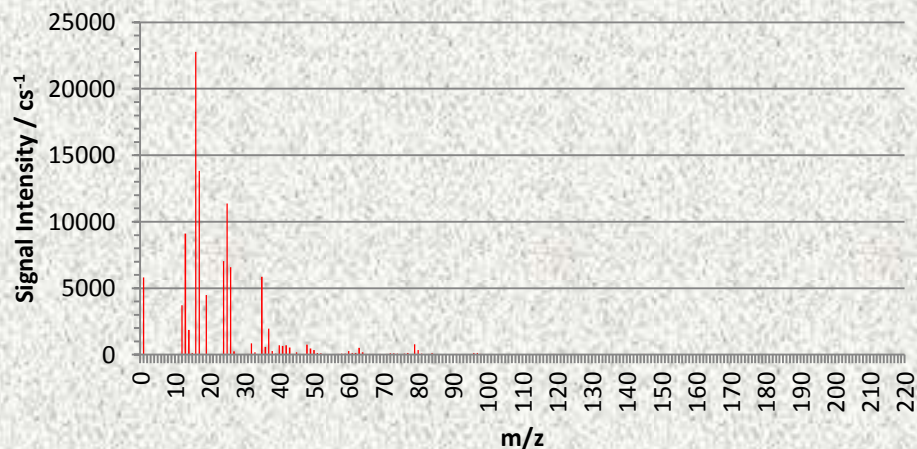

Hydrocarbon contamination

Warm Up

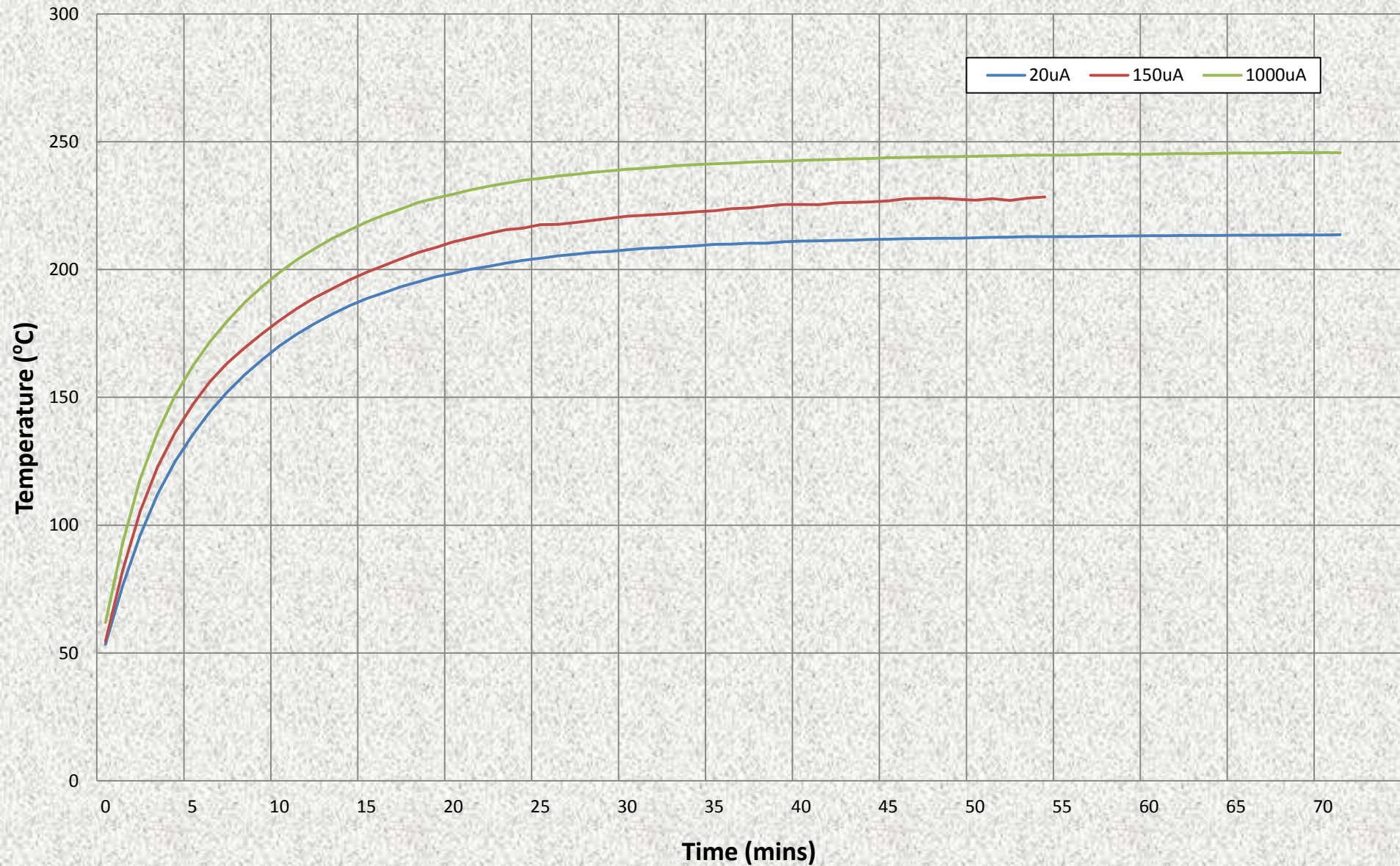

Cool Down

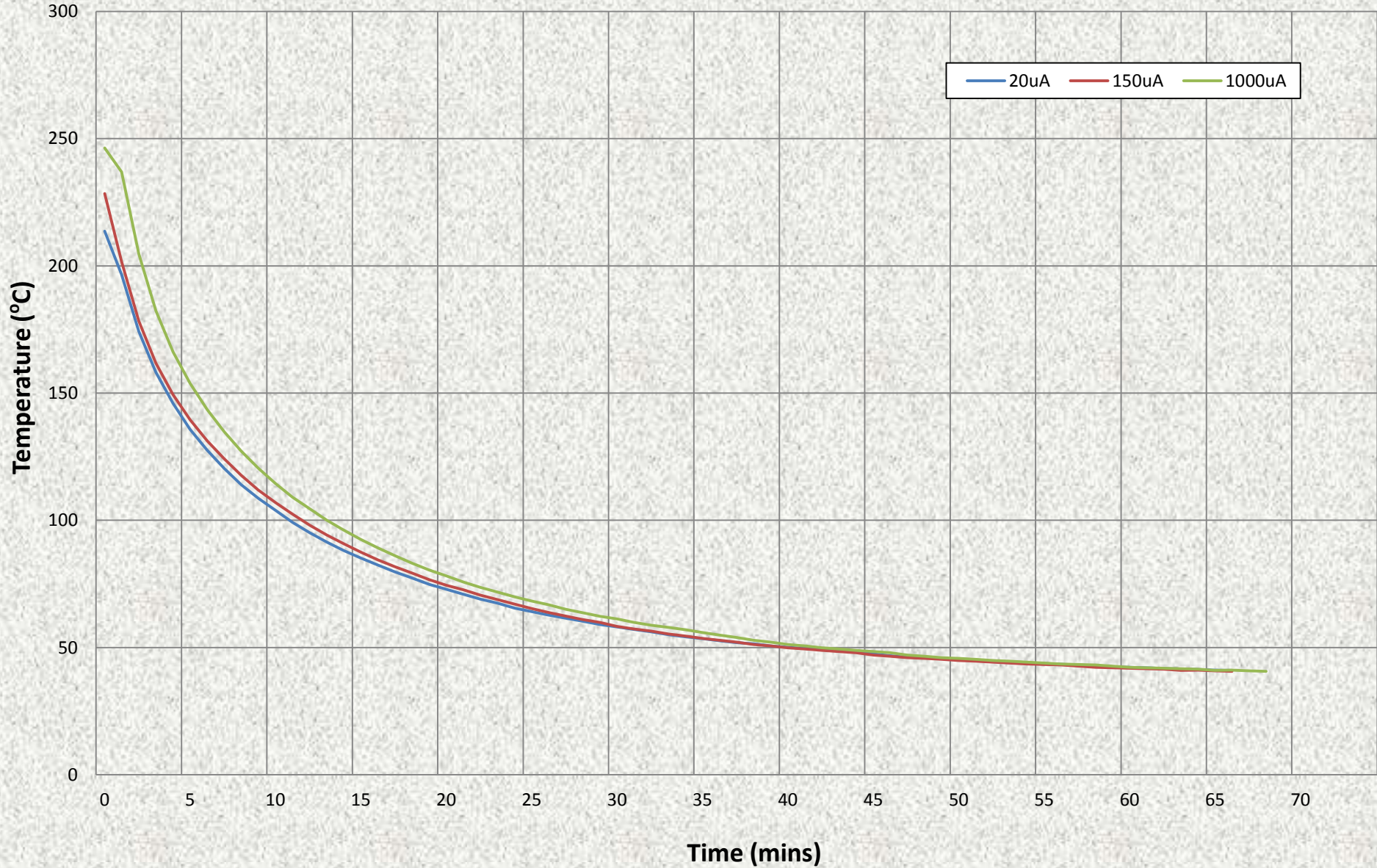

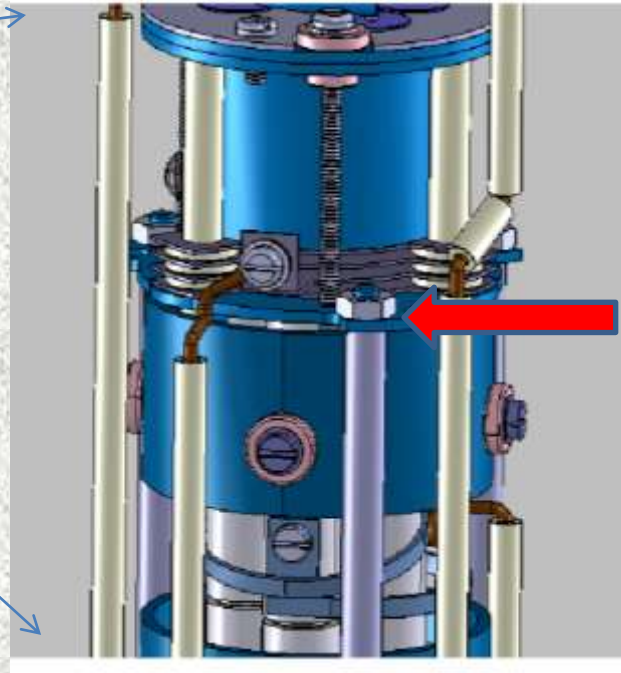
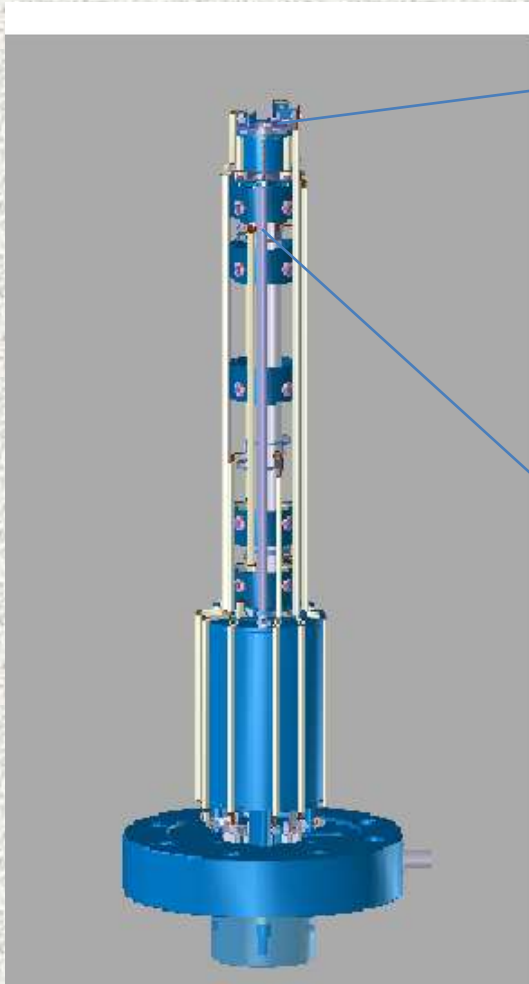

$\leq 32 \text{ degC}$

Conclusions;

Reduce the operating pressure /partial pressure

Clean/dry/inert vent -- and/or a 40 min cool down

Run regular PM template files

Advanced coatings ----- anyone interested let me know

Thank you.

